

Turmdrehkran

Tower Crane / Grue à tour / Gru a torre
Grúa torre / Guindaste de torre

280 EC-H 12 FR.tronic®

280 EC-H 12 Litronic®

280 EC-H 12 FR.tronic®
280 EC-H 12 Litronic®

280 EC-H 16 FR.tronic®
280 EC-H 16 Litronic®

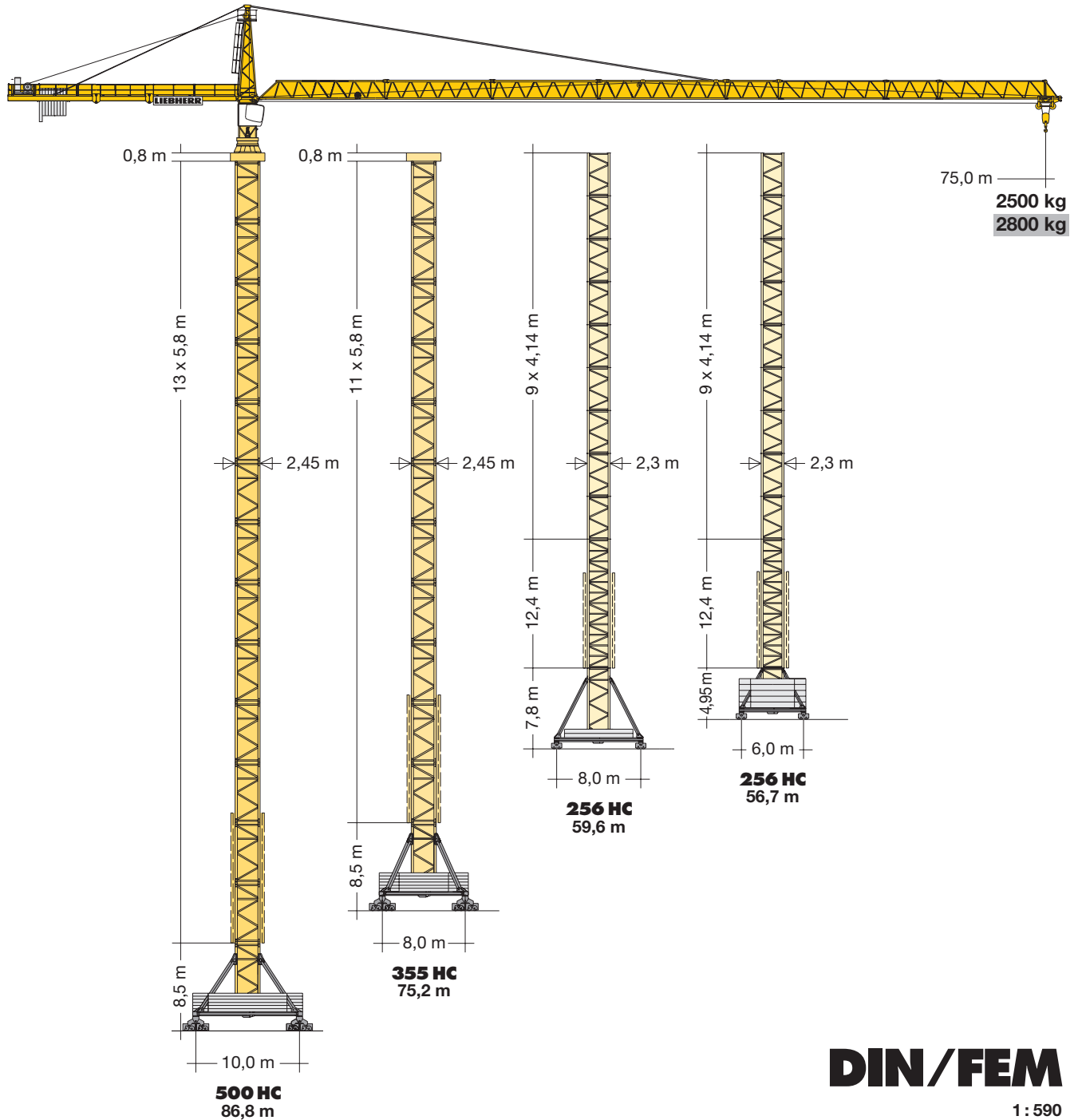

LIEBHERR

Ausladung und Tragfähigkeit

Radius and capacity / Portée et charge / Sbraccio e portata / Alcances y cargas / Alcance e capacidade de carga

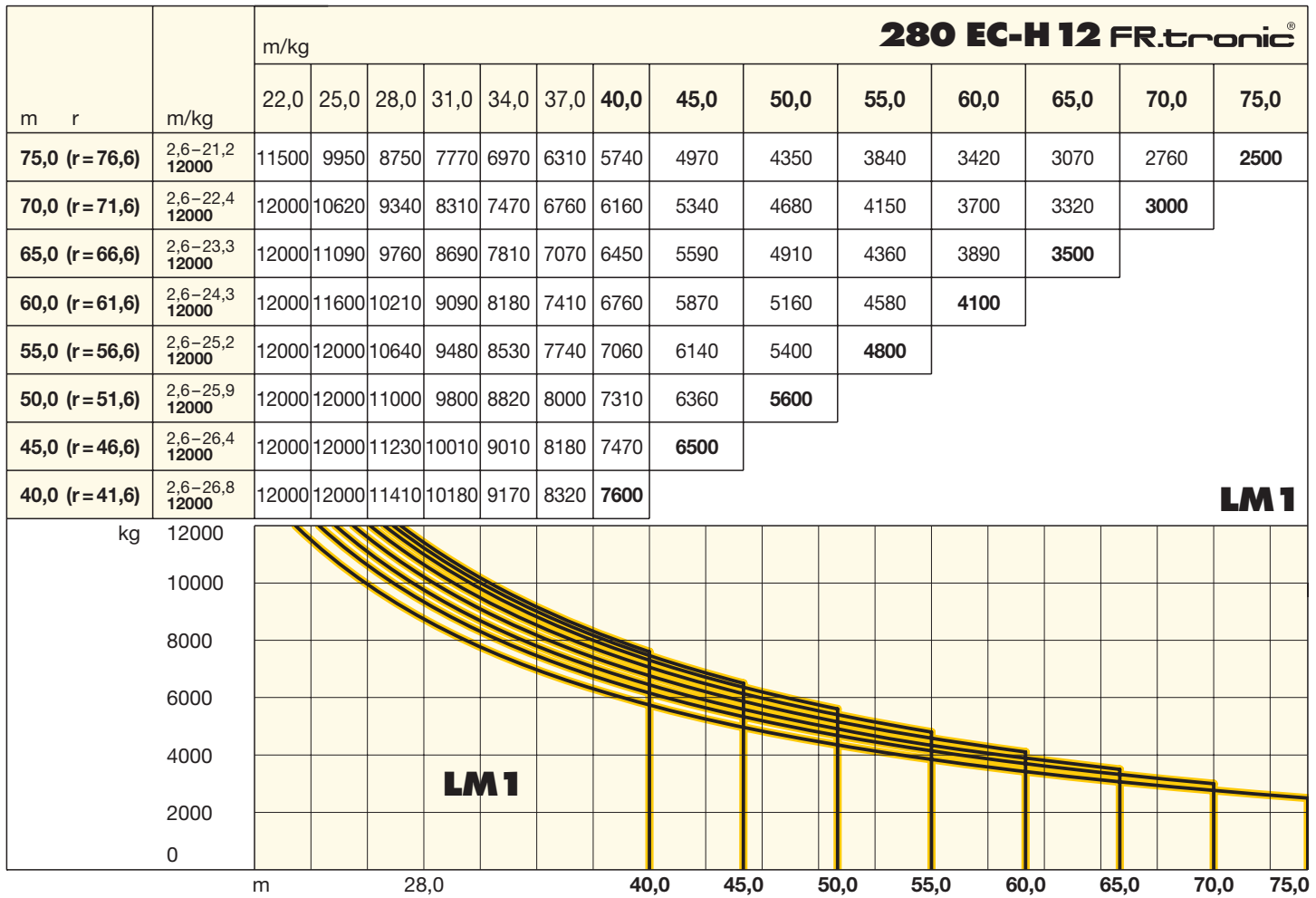

Antriebe FR.tronic®/Litronic®

Driving units / Mécanismes d'entraînement / Azionamenti / Mecanismos / Mecanismos

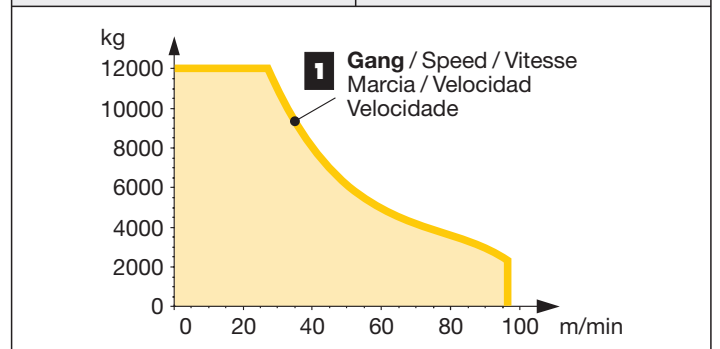
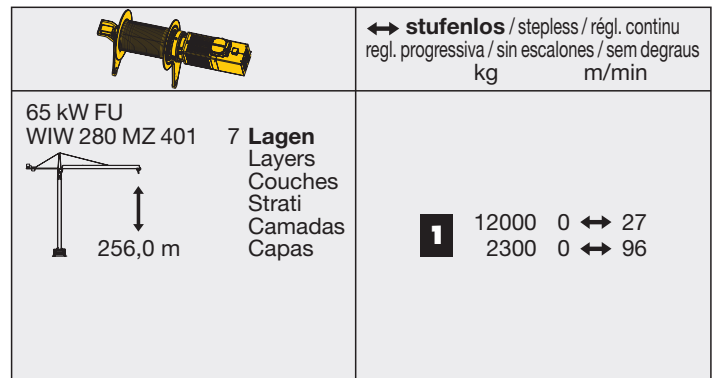
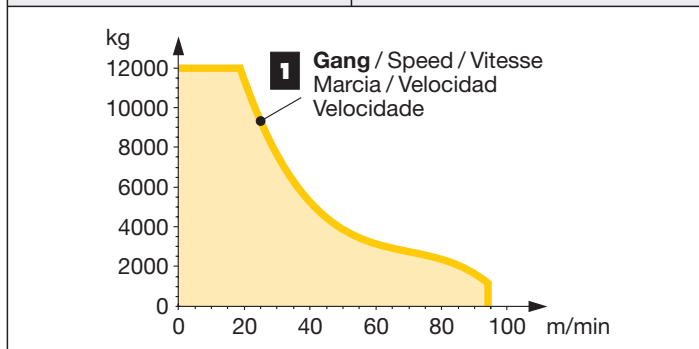
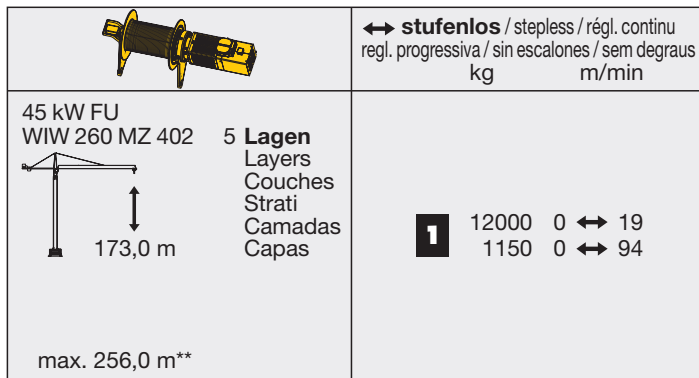

** Weitere Hublastdaten: siehe Betriebsanleitung. / Further hoist load data: see instruction manual. / Autres données de la charge de levage: voir manuel d'instruction. / Altri dati sui carichi sollevati: consultare il manuale d'istruzione. / Alturas bajo granco superiores según manual. / Outras tabelas de carga: consultar manual de instruções.

Ausladung und Tragfähigkeit

Radius and capacity / Portée et charge / Sbraccio e portata / Alcances y cargas / Alcance e capacidade de carga

		280 EC-H 12 Litronic®														
m	r	m/kg	m/kg													2800
			22,0	25,0	28,0	31,0	34,0	37,0	40,0	45,0	50,0	55,0	60,0	65,0	70,0	
75,0	(r=76,6)	2,6-22,9 12000	12000	10860	9560	8500	7640	6920	6310	5470	4800	4250	3800	3410	3090	2800
70,0	(r=71,6)	2,6-25,6 12000	12000	12000	10860	9680	8710	7900	7210	6270	5520	4910	4400	3970	3600	
65,0	(r=66,6)	2,6-26,7 12000	12000	12000	11400	10160	9150	8310	7590	6610	5820	5180	4650	4200		
60,0	(r=61,6)	2,6-27,9 12000	12000	12000	11940	10650	9600	8710	7970	6940	6120	5460	4900			
55,0	(r=56,6)	2,6-29,1 12000	12000	12000	12000	11180	10070	9150	8370	7300	6450	5750				
50,0	(r=51,6)	2,6-30,0 12000	12000	12000	12000	11590	10450	9500	8690	7580	6700					
45,0	(r=46,6)	2,6-30,8 12000	12000	12000	12000	11900	10740	9760	8930	7800						
40,0	(r=41,6)	2,6-31,3 12000	12000	12000	12000	10930	9940	9100								

LM1 + LM2

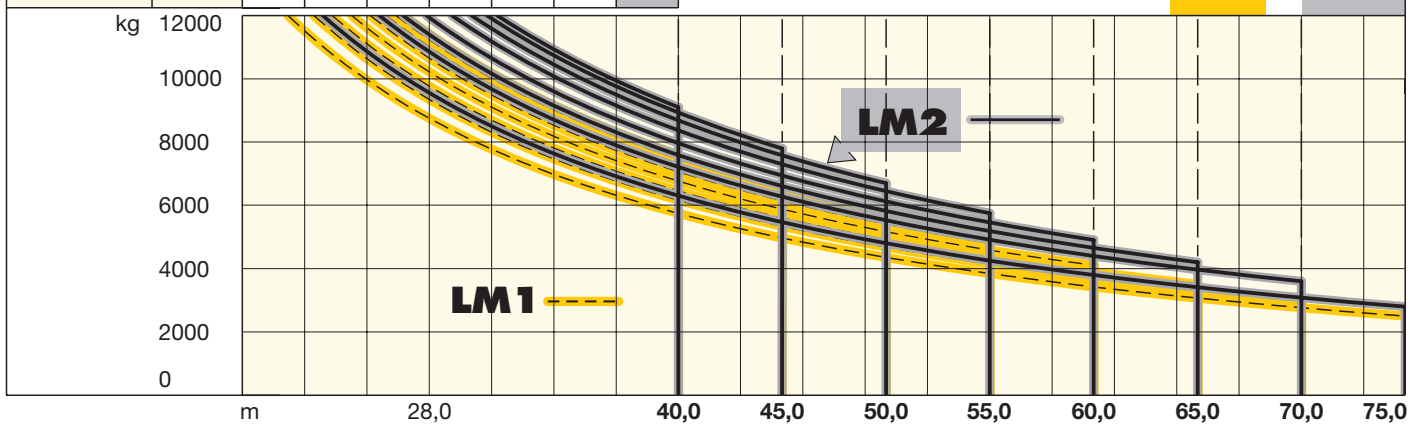

Antriebe FR.tronic®/Litronic®

Driving units / Mécanismes d'entraînement / Azionamenti / Mecanismos / Mecanismos



65 kW FU
WIW 280 VZ 401

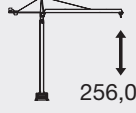



256,0 m

↔ **stufenlos** / stepless / régl. continu
regl. progressiva / sin escalones / sem degraus

kg m/min

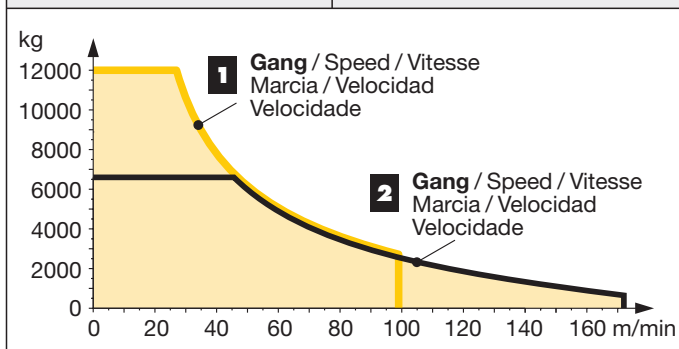
1	12000	0 ↔ 27
	2300	0 ↔ 99
2	6600	0 ↔ 48
	650	0 ↔ 172





110 kW FU
WIW 300 VZ 417

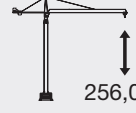

256,0 m

↔ **stufenlos** / stepless / régl. continu
regl. progressiva / sin escalones / sem degraus



kg m/min

1	12000	0 ↔ 47
	5400	0 ↔ 83
2	6400	0 ↔ 82
	2800	0 ↔ 143
3	3500	0 ↔ 137
	1100	0 ↔ 238

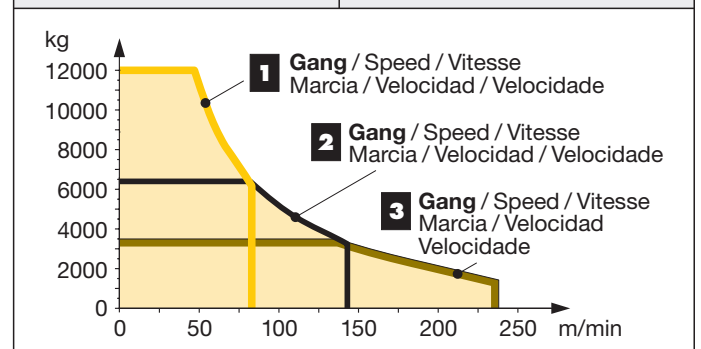
max. 300,0 m**



LM 2 Abweichende Geschwindigkeiten und Betriebsbedingungen. / Variant speeds and service conditions. / Vitesses et conditions de fonctionnement différentes. / Differenti velocità e condizioni di funzionamento. / Otras velocidades y características de funcionamiento. / Outras velocidades e características de funcionamento.

	0 ↔ 0,7 U/min sl./min tr./min	2 x 7,5 kW FU
	0 ↔ 110,0 m/min	7,5 kW FU
	25,0 m/min	4 x 7,5 kW 500 HC (550 HC) 4 x 5,5 kW 355 HC (390 HC) 2 x 7,5 kW 256 HC (290 HC)













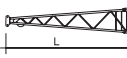



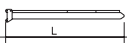





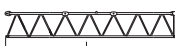



 kVA	45 kW FU	65 kW FU	65 kW FU	110 kW FU
	63,0	86,0	86,0	128,0

Litronic® kVA reduzierbar bei zu geringer Netz-Anschlussleistung, siehe BAL. / kVA can be reduced in case of too little power of the mains, see instruction manual. / kVA peut être réduit en cas de trop faible puissance du réseau, voir manuel d'instruction. / kVA riducibili in caso di potenza di rete ridotta (si veda manuale uso e manutenzione) / kVA variable para potencia de red demasiado pequeña, ver Manual de instrucciones. / kVA reduzível no caso de capacidade da rede elétrica muito baixa, ver manual de instruções.

Kolli-Liste

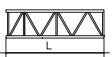
Packing List / Liste de colisage / Lista dei colli / Lista de contenido / Lista de embalagem

Montagengewichte: siehe Betriebsanleitung. / Erection weights: see instruction manual. / Poids de montage: voir manuel de service. / Pesos de montaje: vedasi le istruzioni sull'uso. / Peso para el montaje: según manual. / Pesos de montagem: vejã-se as instruções p. uso.

Kranoberteil		Upper part of crane / Partie supérieure de grue / Parte superiore della gru	Parte superior grúa / Parte superior do guindaste	L (m)	B (m)	H (m)	kg*	
Pos. Item	Anz. Qty.	Drehbühne / Slewing platform / Ensemble mât-cabine / Piattaforma girevole / Conjunto plataforma de giro / Plataforma giratória			5,49	2,74	2,80	10120
Rep. Voce	Qte. Qta.		1	1				
Pos. Ref.	Cant. Cant.	Turmspitze / Tower head / Porte-flèche / Cuspide / Cabeza de torre / Cabeça de apoio de lança			9,09	1,70	1,92	2800
1	1							
3	1	Gegenausleger-Kopfstück / Counter-jib head / Pointe de contre-flèche / Testa di controbraccio / Tramo punta de contrapluma / Cabeça de contra-lança			8,48	2,45	0,92	3050
4	1		Gegenausleger-Anlenkstück / Counter-jib heel section / Pied de contre-flèche / Settore articolato di controbraccio / Tramo primero-contrapluma / Base articulada da contra-lança			8,44	1,77	0,92
5	1	Gegenausleger-Zwischenstück / Intermediate counter-jib section / Élément interm. de contre-flèche / Spezzione di controbraccio / Tramo intermedio de contrapluma / Peça suplementar da contra-lança				5,22	1,76	0,92
6	1		Ausleger-Anlenkstück / Jib heel section / Pied de flèche / Settore articolato di braccio / Pluma tramo primero / Base articulada de lança			12,26	1,86	1,96
7	1	Ausleger-Zwischenstück / Intermediate jib section / Élément intermédiaire de flèche / Spezzione di braccio / Tramo intermedio pluma / Peça suplementar da lança				10,26	1,63	1,87
1	1				12,28	1,63	1,86	⊕ 2260
1	1				5,32	1,63	1,86	⊕ 820
1	1				10,27	1,63	1,86	⊕ 1220
1	1				10,26	1,63	1,84	⊕ 800
1	1				5,25	1,63	1,84	⊕ 510
8	1	Ausleger-Kopfstück / Jib head section / Pointe de flèche / Punta freccia / Tramo punta de pluma / Cabeça de lança			1,70	1,88	2,05	⊕ 280
9	1		Laufkatze und Lashaken / Trolley and hook / Chariot de distribution et crochet / Carrello con gancio / Carro y gancho / Carro de ponte e gancho			1,89	1,83	1,57
10	1	Hubwerkseinheit / Hoist gear unit / Treuil de levage / Gruppo meccanismo sollevamento / Mecanismo de elevación / Grupo de mecanismo elevatório				2,39	2,20	1,74
Turm		Tower / Mât / Torre						
11	9	Turmstück / Tower section / Élément de mât / Elemento di torre / Tramo torre / Torre			256 HC 4,14	2,30	2,30	2300
11	11				355 HC 6,28	2,45	2,45	5050
13	13				500 HC 6,28	2,45	2,45	6480
12	1	Turmstück lang / Long tower section / Élément de mât long / Elemento di torre, lungo / Tramo de torre largo / Peça de torre, comprida			256 HC 12,42	2,30	2,30	5770
13	1		Grundturmstück / Base tower section / Mât de base / Elemento di torre base / Tramo base / Peça de base de torre			256 HC 8,85 (12,42)	2,30 (2,30)	2,30 (2,30)





Klettereinrichtung

Climbing equipment / Equipement de télescopage / Attrezzatura per allungamento della gru Equipo de trepado / Acesórios p. subida no edificio

14	1	Führungsstück kpl., geteilt / Guide section cpl., split Cage télescopique cpl., dévisée / Gabbia di sopraelevazione compl., suddivisa Torre de montaje, dividida / Peça de guia, subdividida	256 HC	8,39	2,68	2,58 (3,04)	5100
			355 HC	12,39	2,75	1,58	8300
			500 HC	12,39	2,75	1,58	8300
15	1	Hydraulikanlage, Stütz- und Klettertraverse / Hydraulic unit, supporting and climbing cross members / Système hydraulique avec traverses d'appui et de télescopage / Sistema hidráulico, travesa de appoggio e allungamento gru Sistema hidráulico con traviesas de apoyo y trepado / Instalação hidráulica, travessa de apoio e subida	256 HC	2,10	1,25	1,00	1150
			355 HC	2,10	1,10	1,00	1810
			500 HC	2,10	1,10	1,00	1810

Unterwagen

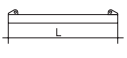
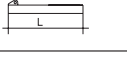
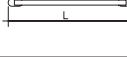
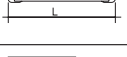
Undercarriage / Châssis / Carro della gru Carro con mástil / Carro de guindaste

16	4	Ausgleichsschwinge mit Schwingenlager / Pivot for wheel box / Chape pour bogie / Bilanciere di equilibratura con cuscinetto bilanciere / Balancim com suporte		355 HC	1,60	0,72	1,48	1390
			500 HC					
17	2 4 4	Fahrschemel mit Antrieb / Rail bogie with drive Bogie moteur / Telaio con gruppo propulsore Caja rodillo motriz / Quadro sem grupo de propulsão		256 HC	1,63 (1,46)	0,92 (0,84)	0,95 (0,87)	1690 (920)
			355 HC	1,40	0,75	0,65	920	
			500 HC	1,45	0,82	0,72	1690	
18	2 4 4	Fahrschemel ohne Antrieb / Rail bogie without drive / Bogie fou / Telaio senza gruppo propulsore / Caja rodillo conducido / Quadro com grupo de propulsão		256 HC	1,37 (1,15)	0,62 (0,60)	0,95 (0,87)	1340 (880)
			355 HC	1,10	0,60	0,65	880	
			500 HC	1,30	0,40	0,72	1340	
19	1 2 2	Tragholm lang / Long support arm Longeron long / Longherone lungo Brazo soporte largo / Travessa comprida		256 HC	9,10 (11,95)	0,80 (0,82)	0,80 (0,80)	1650 (2200)
			355 HC	11,82	0,92	0,93	3515	
			500 HC	7,32	0,92	0,93	2330	
20	2	Tragholm kurz / Short support arm Longeron court / Longherone corto Brazo soporte corto / Travessa curta		256 HC	4,45 (5,58)	0,77 (0,65)	0,77 (0,77)	800 (1035)
			355 HC	5,74	0,80	0,90	1600	
			500 HC	7,14	0,80	0,90	2135	
21	2 + 2	Randträger / Border support Traverse / Supporti base Traviesa / Apoio de bordo		256 HC	5,46 – 5,40 (7,52 – 7,46)	0,11 – 0,18 (0,1 – 0,17)	0,16 – 0,38 (0,1 – 0,38)	175 – 525 (366 – 912)
			355 HC	7,30	0,14	0,14	340	
			500 HC	9,30	0,14	0,14	510	
22	4	Stützholm / Support strut Hauban de châssis / Correnti di appoggio Tirante vertical / Travessa de apoio		256 HC	4,14 (6,55)	0,18 (0,22)	0,25 (0,25)	320 (600)
			355 HC	6,06	0,26	0,34	862	
			500 HC	6,98	0,26	0,34	1140	
23	1	Unterwagen-Turmstück / Undercarriage tower section / Mât de châssis / Elemento di torre del carro / Tramo de carro / Peça de torre do chassis		256 HC	3,73 (6,70)	2,62 (2,53)	2,62 (2,53)	2550 (3800)
			355 HC	6,61	2,44	2,44	7475	
			500 HC	6,61	2,44	2,44	7930	
24		Kleinteile, Seile und Abspannungen / Small parts, ropes and holding bars Accessoires, câbles et tirants / Accessori, funi e attrezzi di ancoraggio Despieces, cables y tirantes / Acesórios, cabos e peças de ancoragem	256 HC	9,00	1,60	1,00	4000	
			500 HC					

() **Angaben in Klammern gelten für 8 m-Unterwagen.** / The data in brackets are valid for an undercarriage of 8 m. / Les données techniques indiquées entre parenthèses sont valables pour un châssis de 8 m. / Caratteristiche in (.) valgono per carro di 8 m. / Los datos entre paréntesis son válidos para carro de 8 m. / Características em (.) válidas pelo chassis de 8 m.

* **Einzelgewichte.** / Single weights. / Poids individuels. / Pesì di componenti. / Pesos unitarios. / Pesos de peças componentes.

Konstruktionsänderungen vorbehalten!

Subject to alterations! / Sous réserves de modifications!
Si fa riserva di modifiche! / ¡Sujeto a modificaciones!
Salvo modificação da construçao!

Sämtliche Angaben erfolgen ohne Gewähr.

This information is supplied without liability.
Ces renseignements sont sans garantie. / Le indicazioni contenute si intendono salvo errori ed omissioni.
Declinamos toda responsabilidad derivada de la información proporcionada. / Declinamos qualquer
responsabilidade quanto à informação fornecida.